

DALLA
CORTE

ZERO

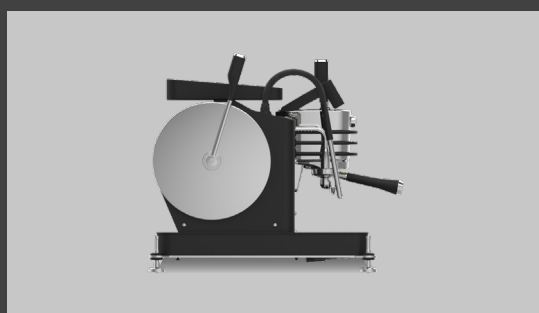

ZERO BARISTA - 2 GRUPPI

DESIGN FUTURISTICO Una macchina dalla forte personalità e dal design accattivante, che mette in risalto le innovazioni tecnologiche di Dalla Corte e il lavoro dei baristi, introducendoli in una dimensione “zero limits” per esprimersi al meglio.

TROVA IL TUO FLOW Con il Fixed Water Flow, il flusso d’acqua è regolabile in grammi per secondo direttamente sullo schermo digitale touch. Ogni singolo gruppo può avere una diversa portata da 3 g/s a 9 g/s, fissa e costante per tutta l’estrazione.

ESTRAI IN MODALITA' FREESTYLE Con il Freestyle Water Flow, ognuna delle leve presenti al lato dei gruppi erogatori di Zero è provvista di 4 step, ogni step è preimpostato con una specifica portata di flusso (3-5-7-9 g/s). Benvenuto nella dimensione “zero limits”.

dimensioni (l x h x p)	870 x 511 x 550 mm
peso	85 kg
potenza massima	4,9 kW
carico connesso	380/400 V 3 N + T, 50/60 Hz - 220/230 V, 50/60 Hz
capacità della caldaia	7,5 l
capacità dei gruppi indipendenti	2 x 0,75 l

ZERO BARISTA - 2 GRUPPI

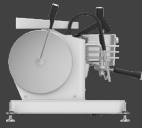

TOTAL WHITE

2 gr 1-MC-ZERO-2-TW-400

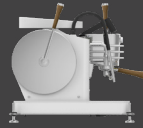

WHITE WALNUT

2 gr 1-MC-ZERO-2-WW-400



WHITE OAK

2 gr 1-MC-ZERO-2-WO-400

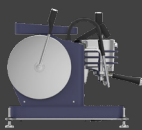

NAVY BLUE

2 gr 1-MC-ZERO-2-TNB-400

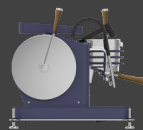

NAVY BLUE WALNUT

2 gr 1-MC-ZERO-2-NBW-400

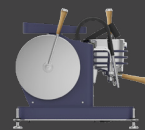

NAVY BLUE OAK

2 gr 1-MC-ZERO-2-NBO-400

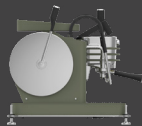

OLIVE GREEN

2 gr 1-MC-ZERO-2-TVO-400



OLIVE GREEN WALNUT

2 gr 1-MC-ZERO-2-VOW-400



OLIVE GREEN OAK

2 gr 1-MC-ZERO-2-VOK-400

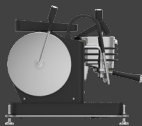

TOTAL DARK

2 gr 1-MC-ZERO-2-TD-400

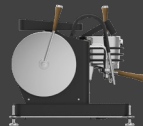

DARK WALNUT

2 gr 1-MC-ZERO-2-DN-400



DARK OAK

2 gr 1-MC-ZERO-2-DK-400

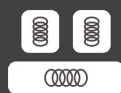

MULTIBOILER



FLOW
CONTROL



COOL TOUCH
STANDARD



WEIGHT
CONTROL



0.75 GROUP



ENERGY
SAVING



CUSTOM
COLOURS



CUSTOM
MATERIALS



58mm FILTER
(optional)

DALLA
CORTE

ZERO

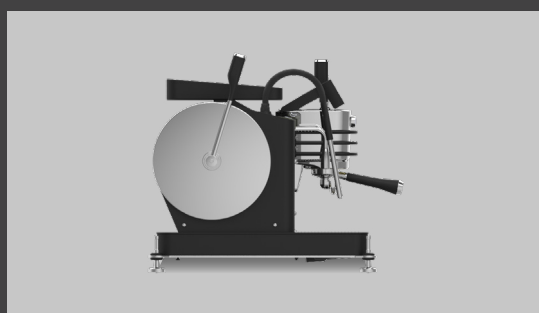
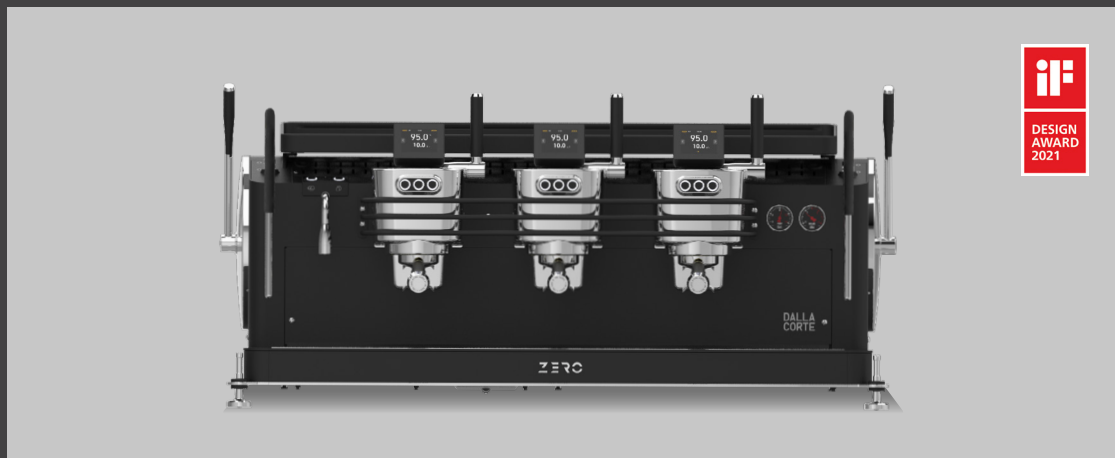

ZERO BARISTA - 3 GRUPPI

DESIGN FUTURISTICO Una macchina dalla forte personalità e dal design accattivante, che mette in risalto le innovazioni tecnologiche di Dalla Corte e il lavoro dei baristi, introducendoli in una dimensione “zero limits” per esprimersi al meglio.

TROVA IL TUO FLOW Con il Fixed Water Flow, il flusso d’acqua è regolabile in grammi per secondo direttamente sullo schermo digitale touch. Ogni singolo gruppo può avere una diversa portata da 3 g/s a 9 g/s, fissa e costante per tutta l’estrazione.

ESTRAI IN MODALITA' FREESTYLE Con il Freestyle Water Flow, ognuna delle leve presenti al lato dei gruppi erogatori di Zero è provvista di 4 step, ogni step è preimpostato con una specifica portata di flusso (3-5-7-9 g/s). Benvenuto nella dimensione “zero limits”.

dimensioni (l x h x p)	1100 x 511 x 550 mm
peso	110 kg
potenza massima	7 kW
carico connesso	380/400 V 3 N + T, 50/60 Hz - 220/230 V, 50/60 Hz
capacità della caldaia	13 l
capacità dei gruppi indipendenti	3 x 0,75 l

ZERO BARISTA - 3 GRUPPI

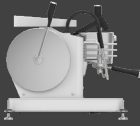

TOTAL WHITE

3 gr 1-MC-ZERO-3-TW-400



WHITE WALNUT

3 gr 1-MC-ZERO-3-WW-400



WHITE OAK

3 gr 1-MC-ZERO-3-WO-400

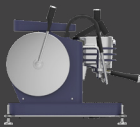

NAVY BLUE

3 gr 1-MC-ZERO-3-TNB-400

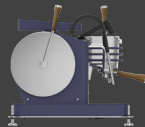

NAVY BLUE WALNUT

3 gr 1-MC-ZERO-3-NBW-400



NAVY BLUE OAK

3 gr 1-MC-ZERO-3-NBO-400

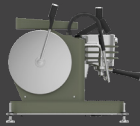

OLIVE GREEN

3 gr 1-MC-ZERO-3-TVO-400

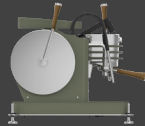

OLIVE GREEN WALNUT

3 gr 1-MC-ZERO-3-VOW-400



OLIVE GREEN OAK

3 gr 1-MC-ZERO-3-VOK-400

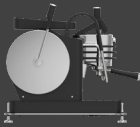

TOTAL DARK

3 gr 1-MC-ZERO-3-TD-400

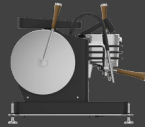

DARK WALNUT

3 gr 1-MC-ZERO-3-DN-400

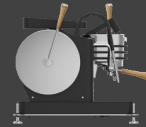

DARK OAK

3 gr 1-MC-ZERO-3-DK-400

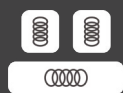

MULTIBOILER



FLOW
CONTROL



COOL TOUCH
STANDARD



WEIGHT
CONTROL



0.75 GROUP



ENERGY
SAVING



CUSTOM
COLOURS



CUSTOM
MATERIALS



58mm FILTER
(optional)